

Eperfil

▪ Sistemas Inteligentes em Alumínio ▪



+E2000
Série

V.01



+E2000

(Câmara Europeia 40mm)

Tipologias

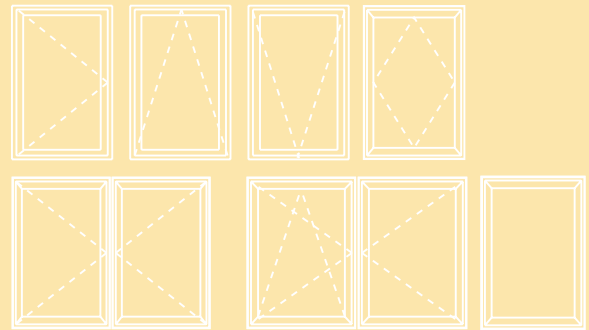

Desempenho do Sistema +E2000 Tipologia com vidro $U_g = 1,0 \text{ W/m}^2\text{K}$

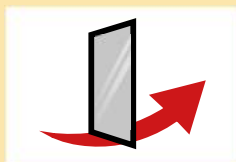

Permeabilidade ao Ar

3
Classe
(norma de ensaio EN 1026)

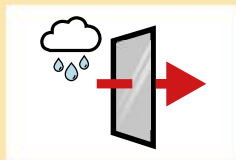

Estanquidade à Água

7A
Classe
(norma de ensaio EN 1027)

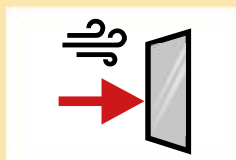

Resistência ao Vento

C5
Classe
(norma de ensaio EN 12211)

Coefficiente de Transmissão Térmica

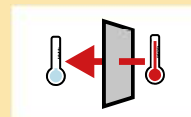

Transmissão Térmica U_w :

3,9 $\text{W/m}^2\text{K}$

Coefficiente de Atenuação Acústica

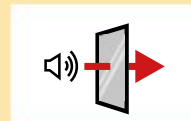

Atenuação Acústica R_w (C,Ctr):

32 (-5)

Sistema de Etiquetagem Energética de Produtos

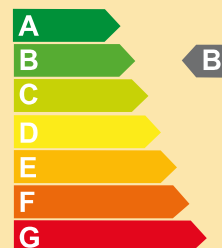

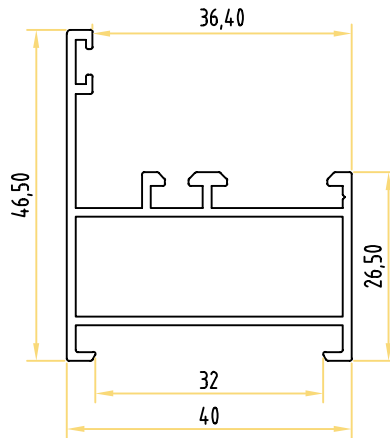

Acessórios

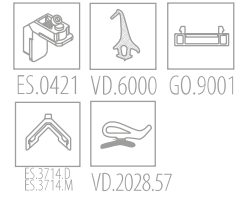

+E2003

Aro Fixo Pequeno
Perímetro: 0,25m

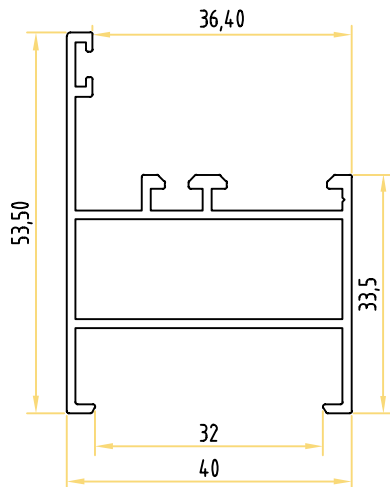

Acessórios

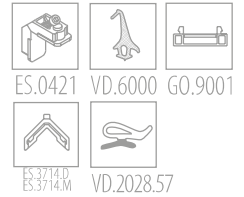

+E2040

Aro Fixo Médio
Perímetro: 0,30m

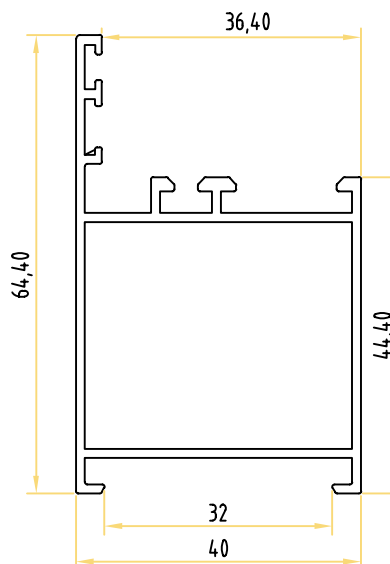

Acessórios

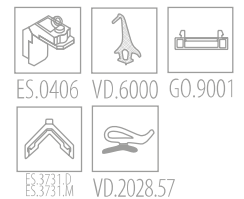

+E2008

Aro Fixo Grande
Perímetro: 0,28m

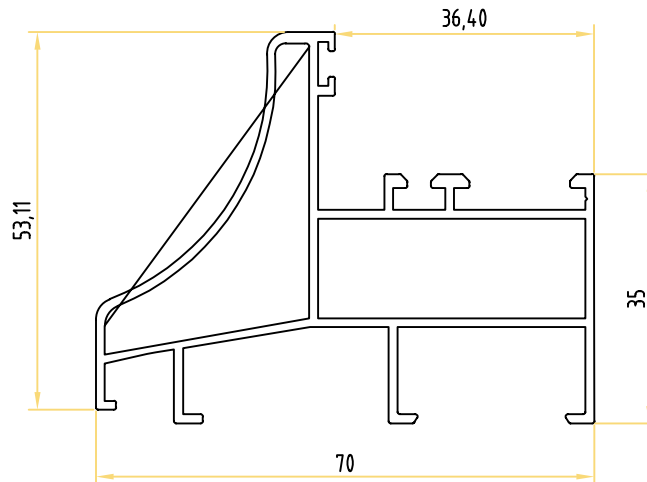

Acessórios



+E2068

Aro Fixo Rústico
Perímetro: 0,38m

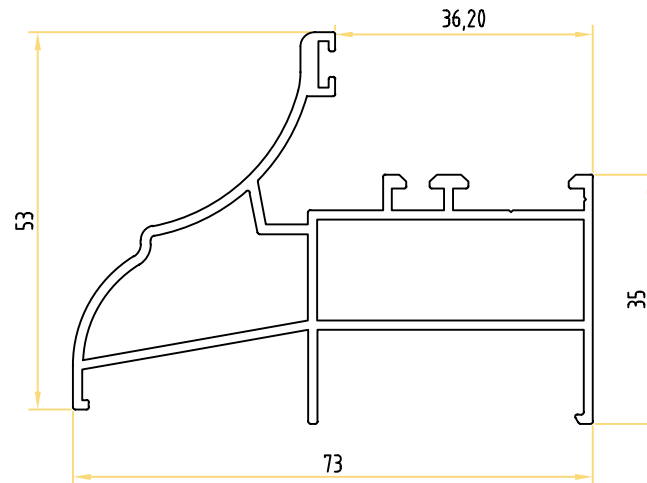

Acessórios

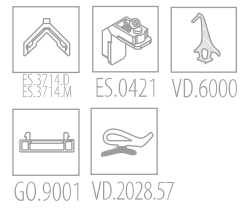

+E2065

Aro Fixo Rústico
Perímetro: 0,36m

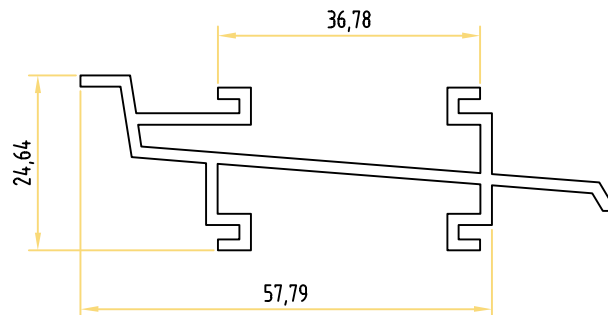

+A1017

Soleira de Condensação
Perímetro: 0,34m

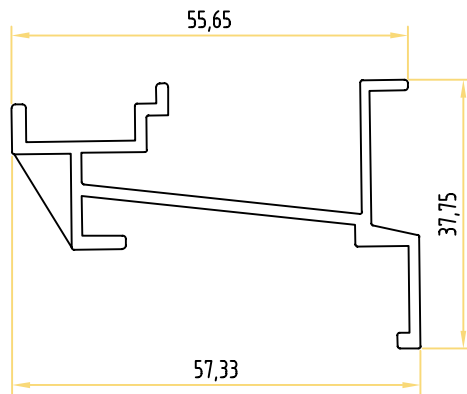

+A1117

Soleira de Condensação
Perímetro: 0,28m

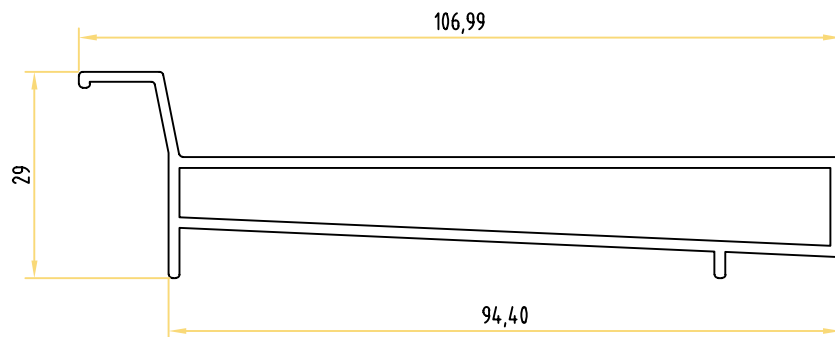

+E2164

Soleira de Condensação
Perímetro: 0,28m

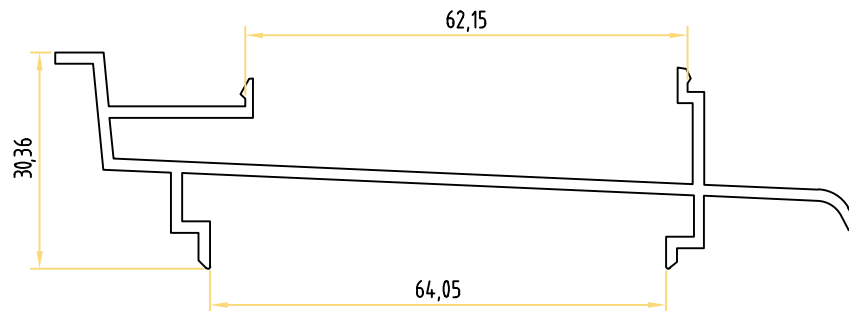

+E2064

Soleira de Condensação
Perímetro: 0,40m

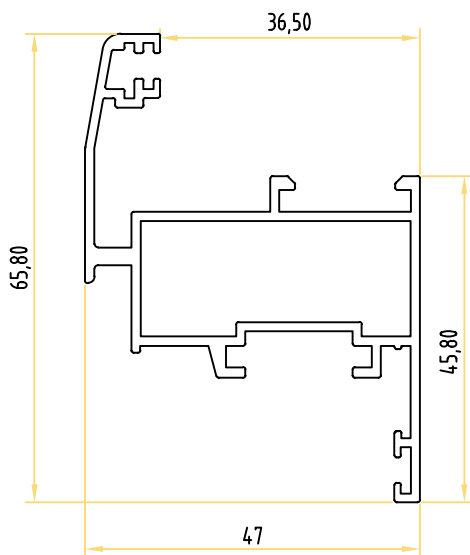

Acessórios



+E2036

Aro Móvel Pequeno Estreito Elítico
Perímetro: 0,35m

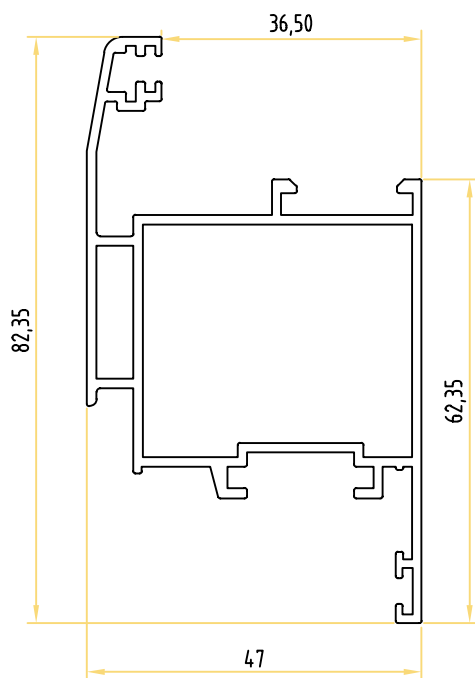

Acessórios



+E2037

Aro Móvel Médio Elítico
Perímetro: 0,38m

+E2045 Caixa 30,5	+E2014 Caixa 26	+E2018 Caixa 24	+E2015 Caixa 21,9	+E2019 Caixa 19,1	+E2016 Caixa 12	+E2017 Caixa 9	+E2217 Caixa 3,5
6	10,5	12,5	14,6	17,4	24,6	27,5	33

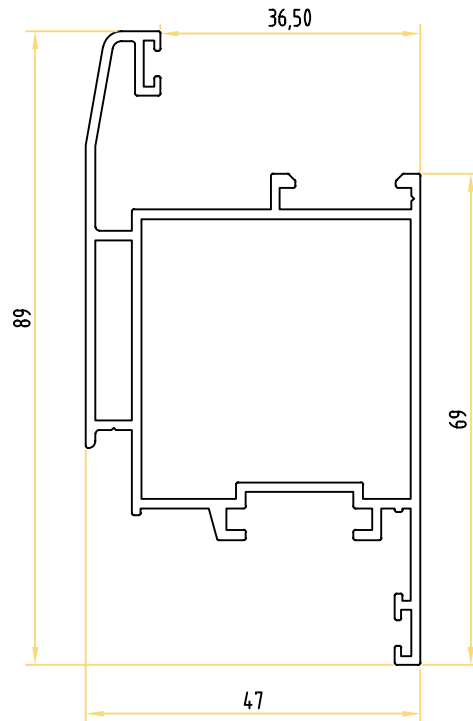

+E2007

Aro Móvel Grande Elítico
Perímetro: 0,36m

Acessórios

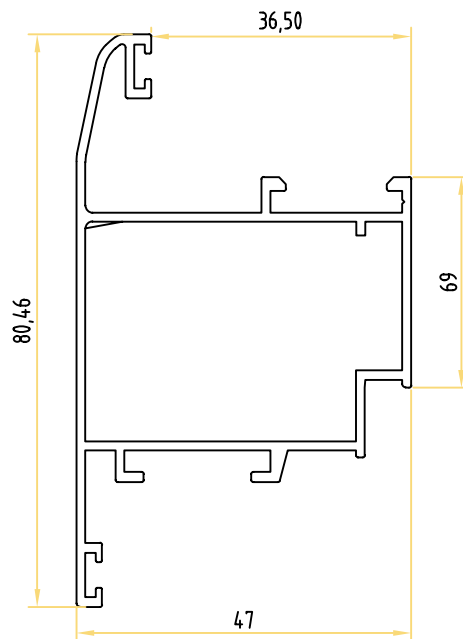

+E2111

Aro Móvel Grande
de Abertura Exterior Elítico
Perímetro: 0,40m

Acessórios

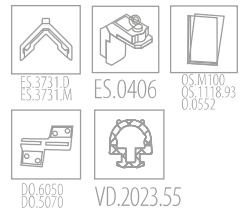

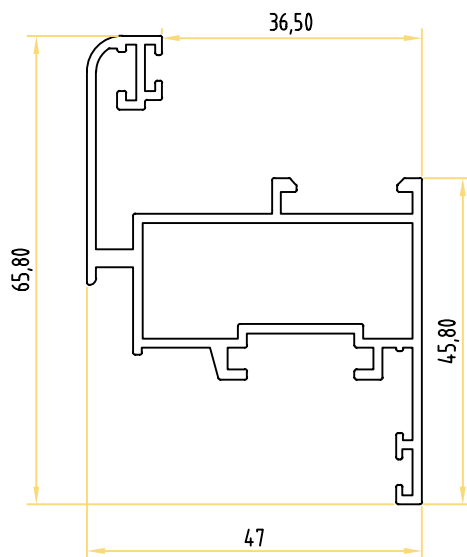

Acessórios

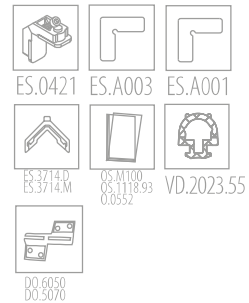

+E2005

Aro Móvel Pequeno Curvo
Perímetro: 0,33m

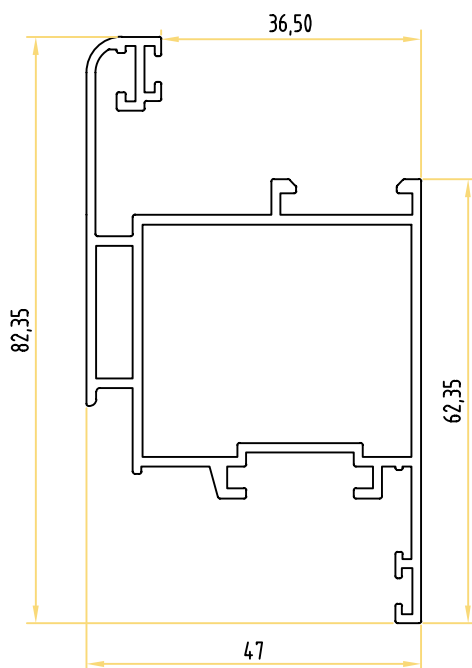

Acessórios

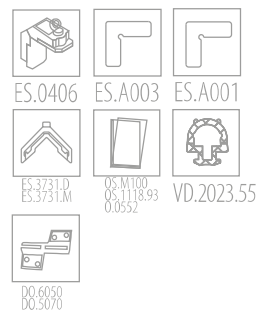

+E2010

Aro Móvel Grande Redondo
Perímetro: 0,36m

+E2045

Caixa 30,5

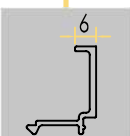

+E2014

Caixa 26

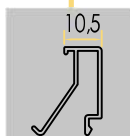

+E2018

Caixa 24

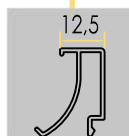

+E2015

Caixa 21,9

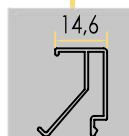

+E2019

Caixa 19,1

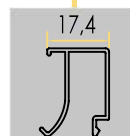

+E2016

Caixa 12

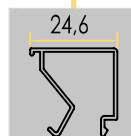

+E2017

Caixa 9

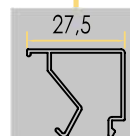

+E2217

Caixa 3,5

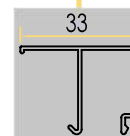

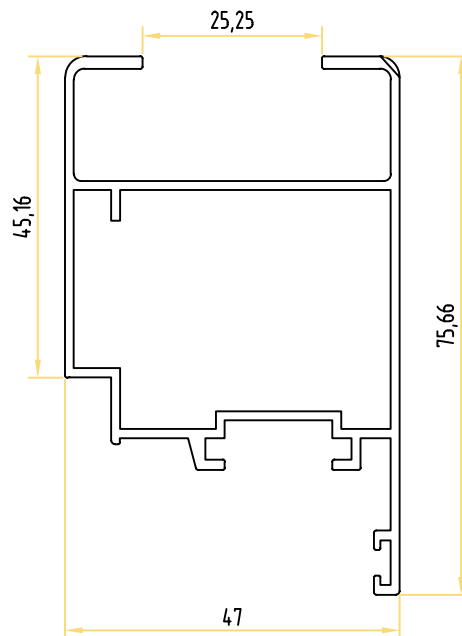

Acessórios

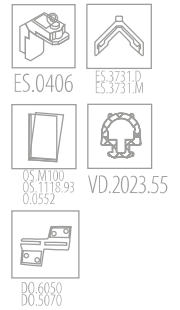

+E2085

Aro Móvel Grande para Lâminas
Perímetro: 0,36m

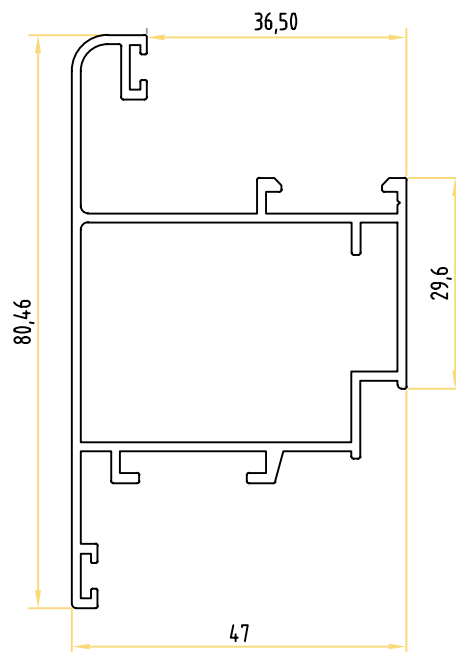

Acessórios

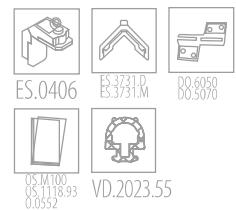

+E2110

Aro Móvel de Abertura
Exterior Redondo
Perímetro: 0,36m





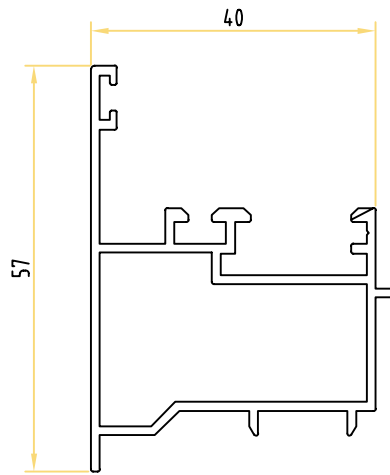

Acessórios



TP.0255



VD.6000

+E2148

Inversor
Perímetro: 0,29m

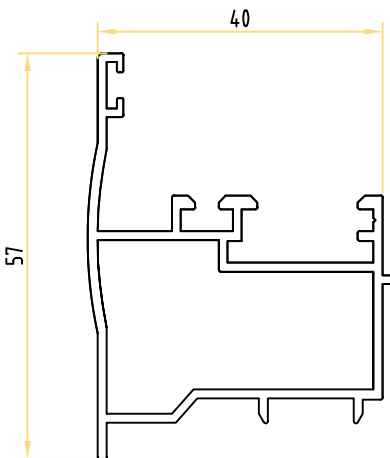

Acessórios



TP.0279



VD.6000

+E2149

Inversor Rústico
Perímetro: 0,30m

Acessórios

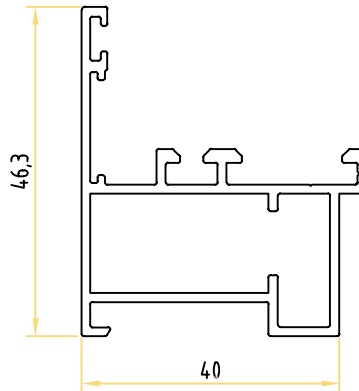

+E2146

Inversor de Aro Fixo
Perímetro: 0,25m

Acessórios

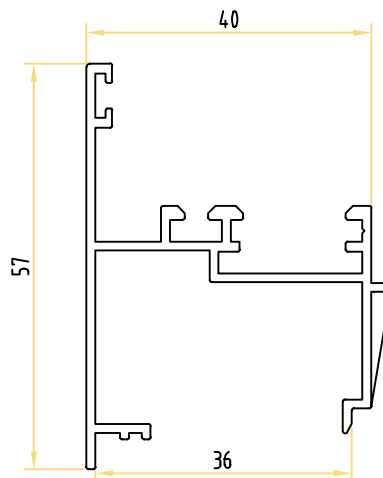

+E2147

Inversor
Perímetro: 0,35m



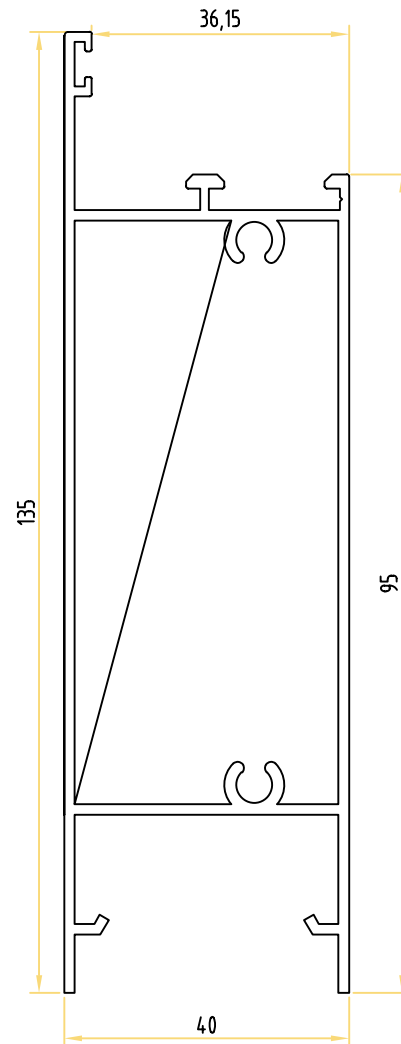
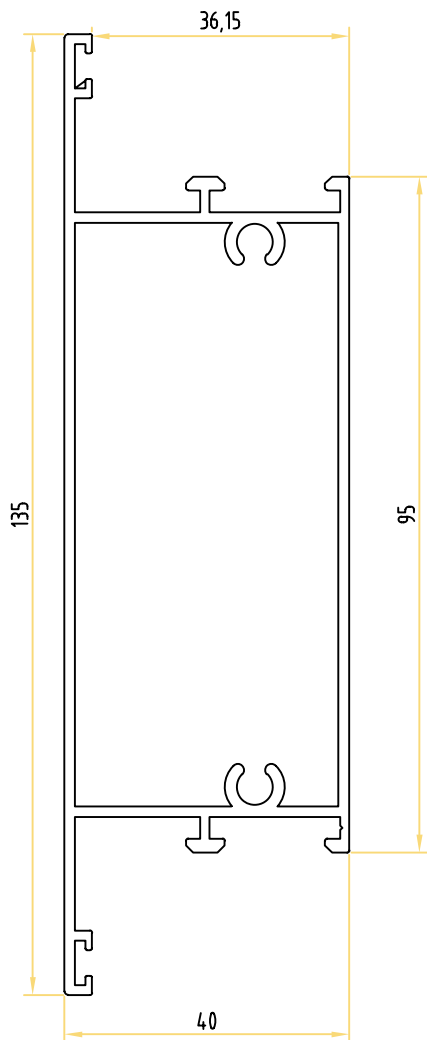

+E2012

Travessa Grande
Perímetro: 0,44m

+E2058

Almofada de Fundo
Perímetro: 0,46m

+E2045
Caixa 30,5

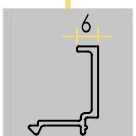

+E2014
Caixa 26

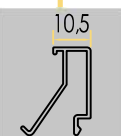

+E2018
Caixa 24



+E2015
Caixa 21,9

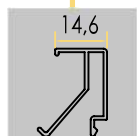

+E2019
Caixa 19,1



+E2016
Caixa 12

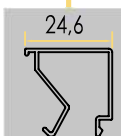

+E2017
Caixa 9

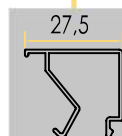

+E2217
Caixa 3,5

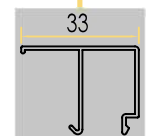

Acessórios

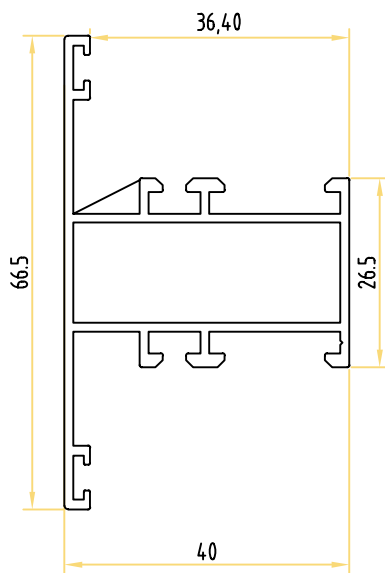

+E2001

Travessa Pequena
Perímetro: 0,33m

Acessórios

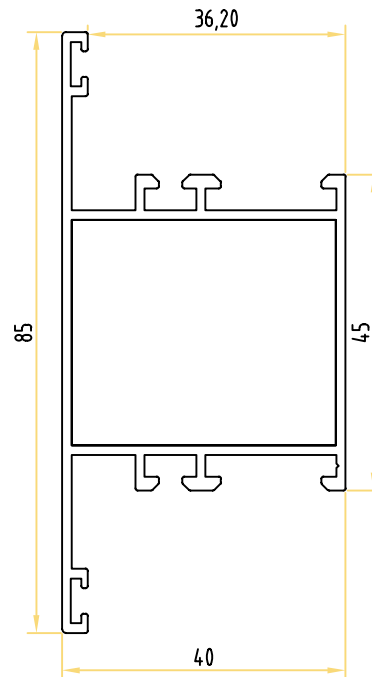

+E2039

Travessa Média
Perímetro: 0,36m

Acessórios



VD.6000

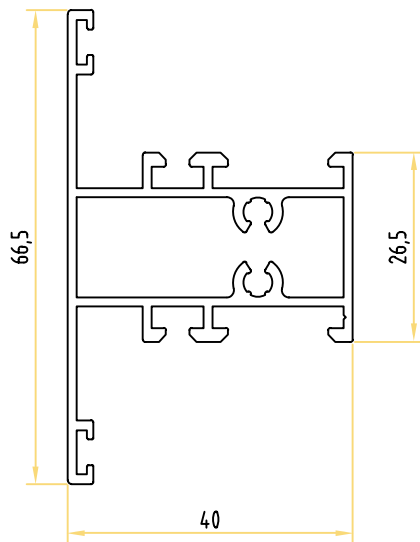

+E2002

Travessa Pequena c/Olhais
Perímetro: 0,33m

Acessórios



VD.6000

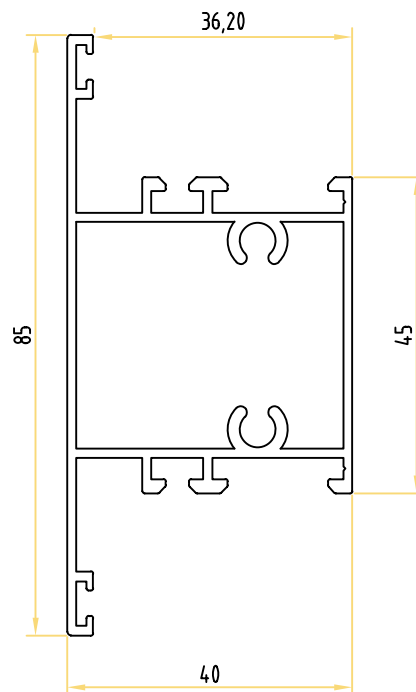

+E2139

Travessa Pequena c/Olhais
Perímetro: 0,36m

Acessórios



VD.6000

Acessórios



VD.6000

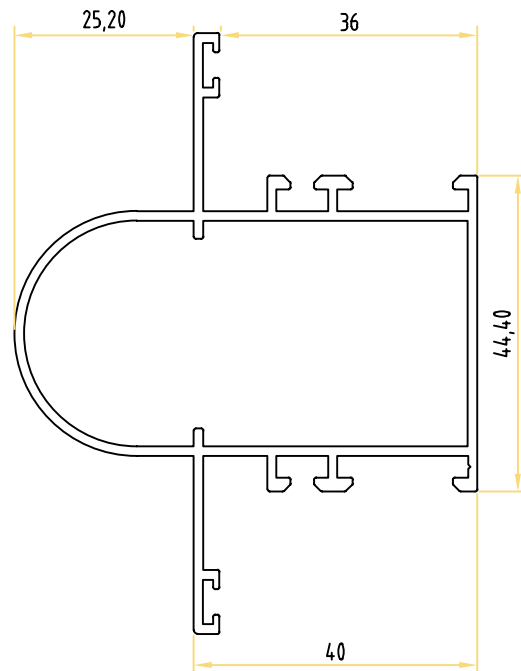
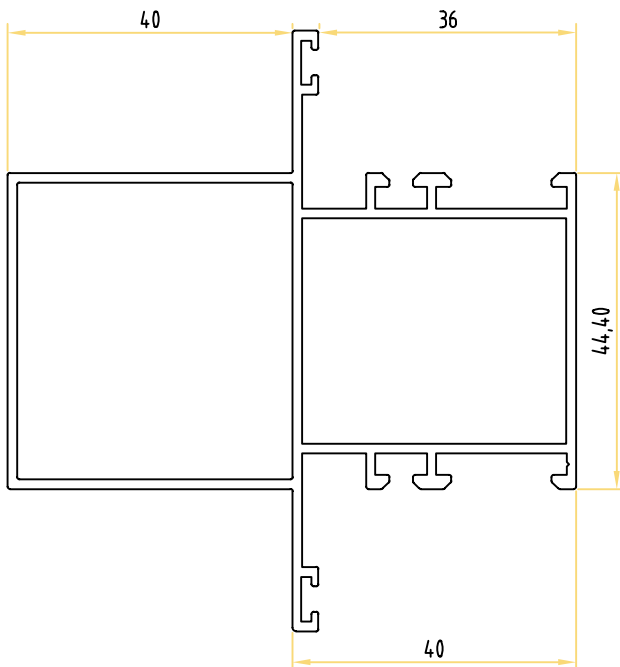

+E2059

Montante Reto
Perímetro: 0,44m

+E2063

Montante Redondo
Perímetro: 0,35m

+E2045
Caixa 30,5

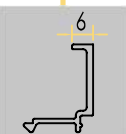

+E2014
Caixa 26

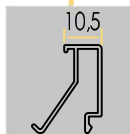

+E2018
Caixa 24



+E2015
Caixa 21,9

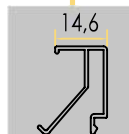

+E2019
Caixa 19,1

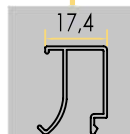

+E2016
Caixa 12

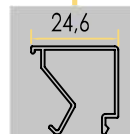

+E2017
Caixa 9

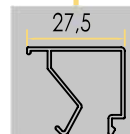

+E2217
Caixa 3,5

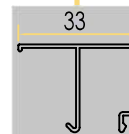

Acessórios

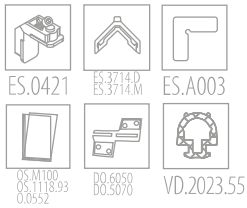

Acessórios

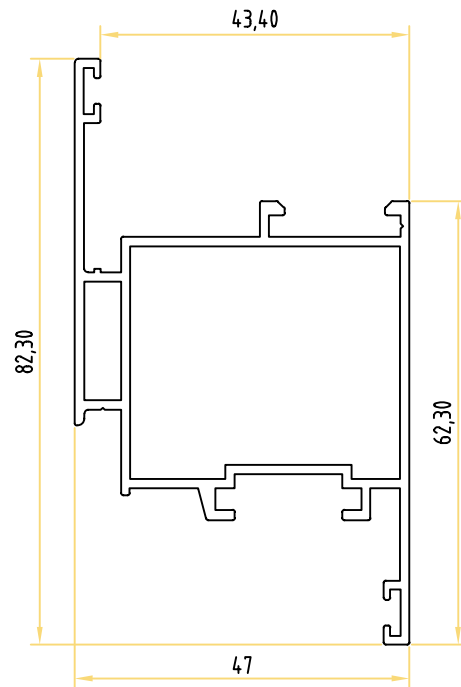
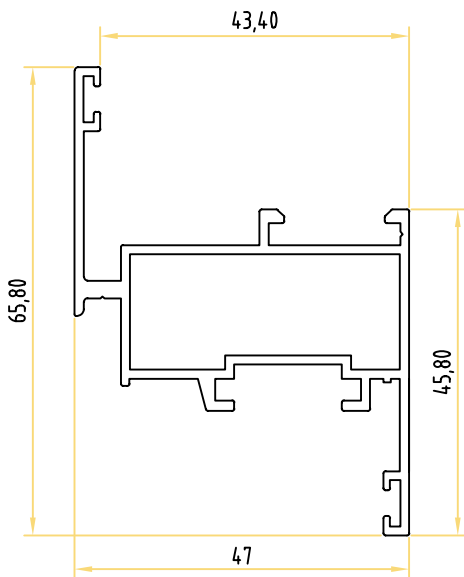
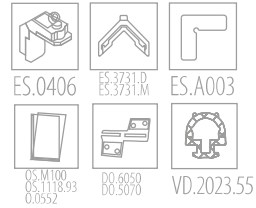

+E2150

Aro Móvel Pequeno Liso
Perímetro: 0,33m

+E2151

Aro Móvel Médio Liso
Perímetro: 0,36m

+E2045 Caixa 37,4	+E2014 Caixa 32,9	+E2018 Caixa 30,9	+E2015 Caixa 28,8	+E2019 Caixa 26	+E2016 Caixa 18,9	+E2017 Caixa 15,9	+E2217 Caixa 10,4
6	10,5	12,5	14,6	17,4	24,6	27,5	33

Acessórios

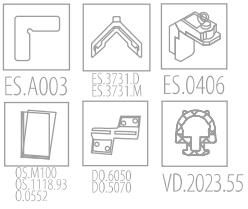

Acessórios

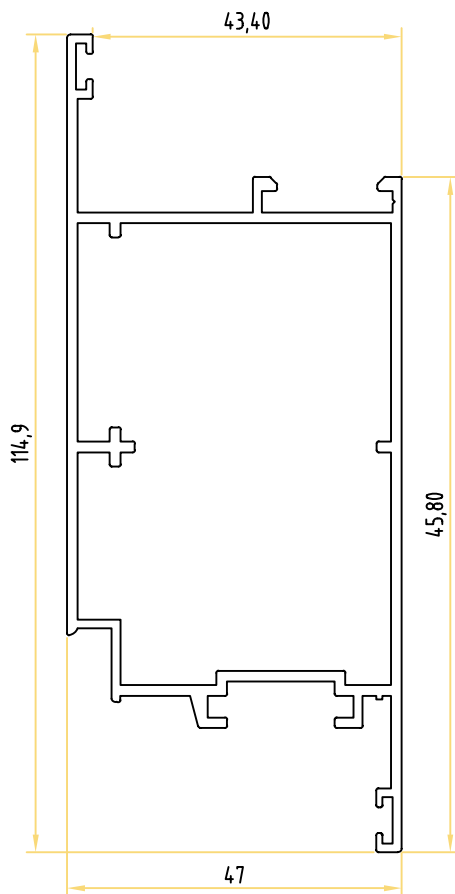
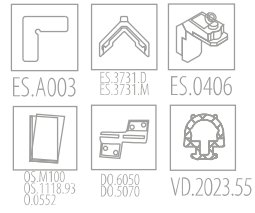

+E2152

Aro Móvel Grande
Perímetro: 0,42m

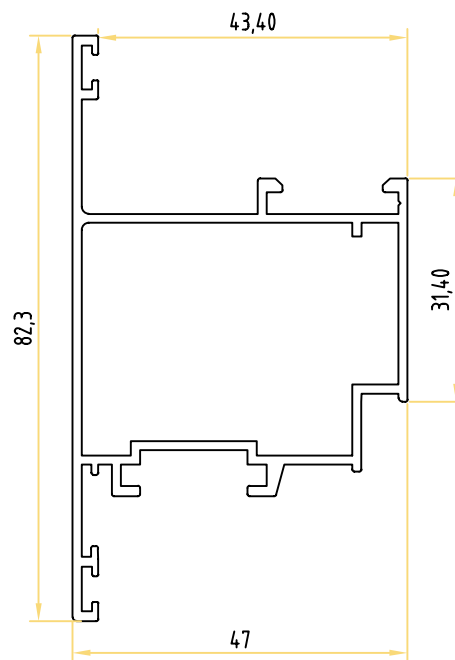

+E2154

Aro Móvel Abertura Exterior
Perímetro: 0,35m

Acessórios

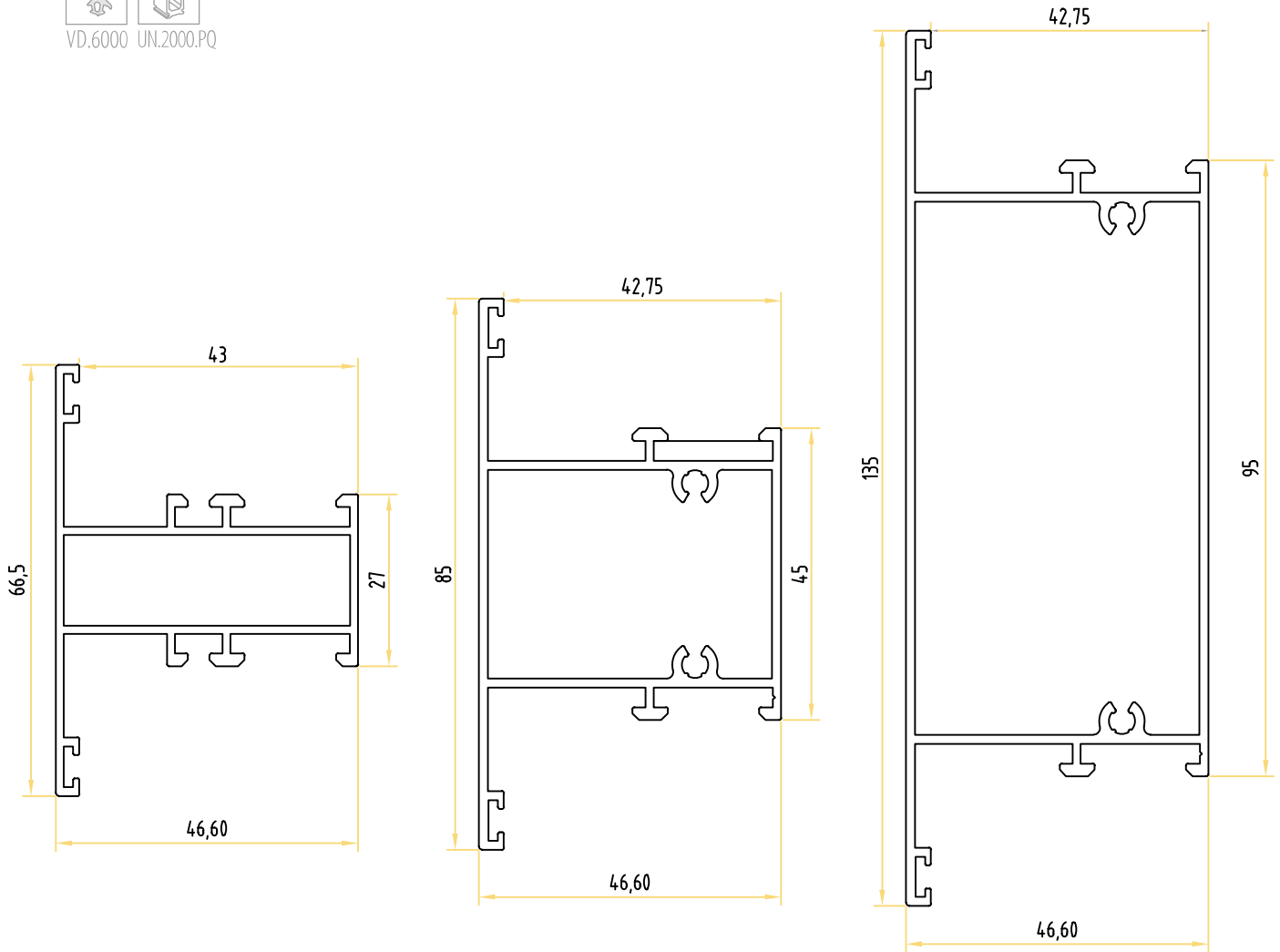

+E2156

Travessa Pequena
Perímetro: 0,34m

+E2153

Almofada 135mm
Perímetro: 0,45m

+E2155

Travessa Média c/Olhais
Perímetro: 0,35m

+E2045

Caixa 37,4

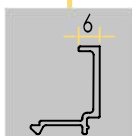

+E2014

Caixa 32,9

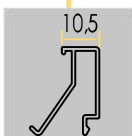

+E2018

Caixa 30,9

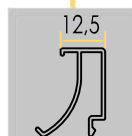

+E2015

Caixa 28,8

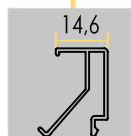

+E2019

Caixa 26

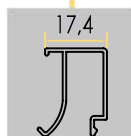

+E2016

Caixa 18,9

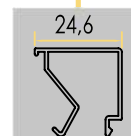

+E2017

Caixa 15,9

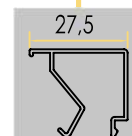

+E2217

Caixa 10,4

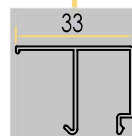

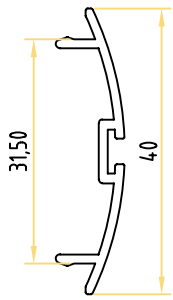

+E2101

Clip vaiVém
Perímetro: 0,10m | 0,12

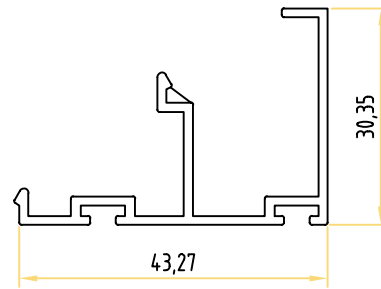

+E2113

Bite de Remate de Fundo
de Portas
Perímetro: 0,24m

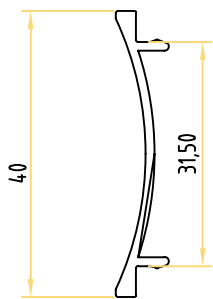

+E2102

Clip vaiVém
Perímetro: 0,10m | 0,12

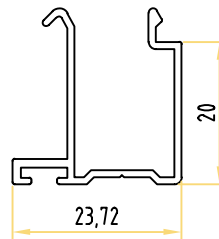

+E2013

Bite p/ Almofada
Perímetro: 0,10m

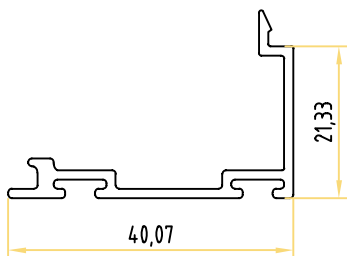

+E2112

Remate Fundo de Porta
Perímetro: 0,15m

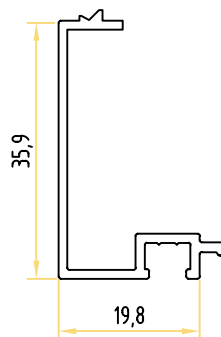

+E2143

Remate de Lâmina
Perímetro: 0,16m

Acessórios

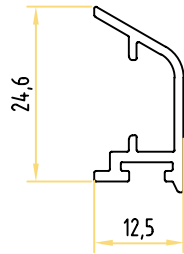

+E2104

Pingadeira
Perímetro: 0,11m

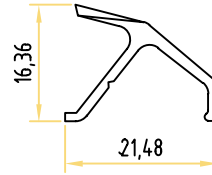

+E2107

Pingadeira
Perímetro: 0,09m

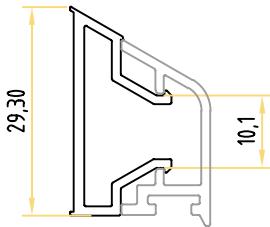

+E2103

Clip
Perímetro: 0,14m

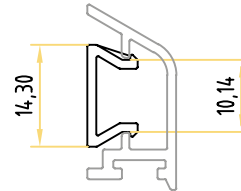

+E2103/C

Clip
Perímetro: 0,06m

Medidas de Corte +E2000

Janela de Abrir de 1 Folha
Abertura Interior

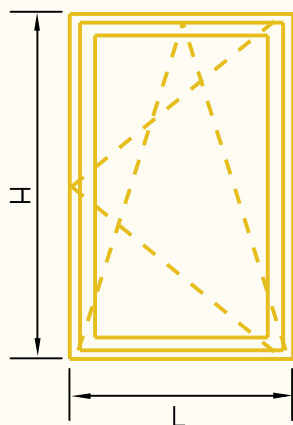

Perfil	Descrição	Corte	Quantidade	Medidas
+E2003	Aro Fixo		2	H L
+E2036	Aro Móvel		2	H-41 L-41
+A1017	Soleira		1	L

Janela de Abrir de 2 Folhas
Abertura Interior

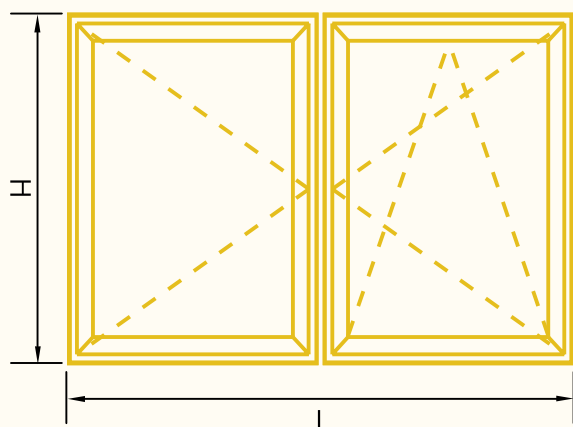

Perfil	Descrição	Corte	Quantidade	Medidas
+E2003	Aro Fixo		2	H L
+E2036	Aro Móvel		4	H-41 L/2-23
+E2148	Inversor		1	H-102
+A1017	Soleira		1	L

Porta de 1 Folha Abertura Interior

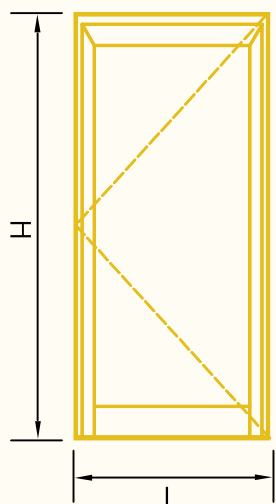

Perfil	Descrição	Corte	Quantidade	Medidas
+E2008	Aro Fixo		2	H
			1	L
+E2037	Aro Móvel		2	H-44
			1	L-77
+E2012	Travessa		1	L-192
+E2013	Travessa		1	L-202

Porta de 2 Folhas Abertura Interior

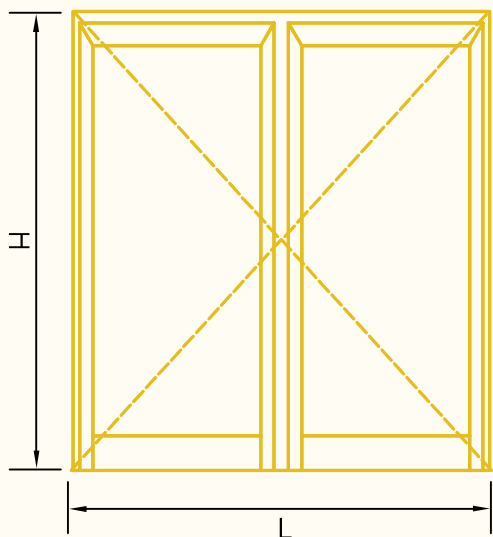

Perfil	Descrição	Corte	Quantidade	Medidas
+E2008	Aro Fixo		2	H
			1	L
+E2037	Aro Móvel		4	H-44
			2	L/2-41
+E2012	Travessa		2	L/2-156
+E2148	Inversor		1	H-75
+E2013	Travessa		2	L/2-166